



10623 Roselle Street, San Diego, CA 92121 • (858) 550-9559 • Fax (858) 550-7322
contactus@accessio.com • www.accessio.com

**MODEL WWP-IIRO-8
WIRELESS TO WIRELESS PAIR
OF ISOLATED INPUTS
AND RELAY OUTPUTS
USER MANUAL**

Notice

The information in this document is provided for reference only. ACCES does not assume any liability arising out of the application or use of the information or products described herein. This document may contain or reference information and products protected by copyrights or patents and does not convey any license under the patent rights of ACCES, nor the rights of others.

IBM PC, PC/XT, and PC/AT are registered trademarks of the International Business Machines Corporation.

Printed in USA. Copyright by ACCES I/O Products, Inc. 10623 Roselle Street, San Diego, CA 92121. All rights reserved.

WARNING!!

ALWAYS CONNECT AND DISCONNECT YOUR FIELD CABLING WITH THE COMPUTER POWER OFF. ALWAYS TURN COMPUTER POWER OFF BEFORE INSTALLING A BOARD, CONNECTING AND DISCONNECTING CABLES, OR INSTALLING BOARDS INTO A SYSTEM WITH THE COMPUTER OR FIELD POWER ON MAY CAUSE DAMAGE TO THE I/O BOARD AND WILL VOID ALL WARRANTIES, IMPLIED OR EXPRESSED.

Warranty

Prior to shipment, ACCES equipment is thoroughly inspected and tested to applicable specifications. However, should equipment failure occur, ACCES assures its customers that prompt service and support will be available. All equipment originally manufactured by ACCES which is found to be defective will be repaired or replaced subject to the following considerations.

Terms and Conditions

If a unit is suspected of failure, contact ACCES' Customer Service department. Be prepared to give the unit model number, serial number, and a description of the failure symptom(s). We may suggest some simple tests to confirm the failure. We will assign a Return Material Authorization (RMA) number which must appear on the outer label of the return package. All units/components should be properly packed for handling and returned with freight prepaid to the ACCES designated Service Center, and will be returned to the customer's/user's site freight prepaid and invoiced.

Coverage

First Three Years: Returned unit/part will be repaired and/or replaced at ACCES option with no charge for labor or parts not excluded by warranty. Warranty commences with equipment shipment.

Following Years: Throughout your equipment's lifetime, ACCES stands ready to provide on-site or in-plant service at reasonable rates similar to those of other manufacturers in the industry.

Equipment Not Manufactured by ACCES

Equipment provided but not manufactured by ACCES is warranted and will be repaired according to the terms and conditions of the respective equipment manufacturer's warranty.

General

Under this Warranty, liability of ACCES is limited to replacing, repairing or issuing credit (at ACCES discretion) for any products which are proved to be defective during the warranty period. In no case is ACCES liable for consequential or special damage arriving from use or misuse of our product. The customer is responsible for all charges caused by modifications or additions to ACCES equipment not approved in writing by ACCES or, if in ACCES opinion the equipment has been subjected to abnormal use. "Abnormal use" for purposes of this warranty is defined as any use to which the equipment is exposed other than that use specified or intended as evidenced by purchase or sales representation. Other than the above, no other warranty, expressed or implied, shall apply to any and all such equipment furnished or sold by ACCES.

Table of Contents

Chapter 1: Introduction	5
Features	5
Applications	5
Functional Description	5
Figure 1-1: Block Diagram Depicting One-Way Signal Flow	6
Figure 1-2: Block Diagram Depicting Two-Way (Pair of Units) Signal Flow	7
Ordering Guide	8
Optional Antennas	8
Pigtail Antenna Extensions	8
Included with your board	8
Optional Accessory	8
Chapter 2: Installation	9
Figure 2-1: Module with the lid open and terminal blocks identified	9
Figure 2-2: Internal radio label and outer enclosure label examples	9
Power	10
Antenna Installation	10
Test Setups	10
Basic Test	10
Medium Scale Test	10
Thorough Scale Test	10
Verify Wireless Connection	11
Figure 2-3: Input and power terminal block signal connection locations	11
Figure 2-4: Relay terminal block signal arrangements	12
Chapter 3: Hardware Details	13
Option Selections	13
Filter Response Jumpers	13
Figure 3-1: Option Selection Map	13
Table 3-1: Input Filter Jumper Selections	13
Chapter 4: Connector Pin Assignments	14
Table 4-1: Screw Terminal Connections	14
Chapter 5: Specifications	15
General	15
Power Requirements	15
900 MHz Radio	15
900 MHz Antenna	15
Isolated Inputs	15
Relay Outputs	16
Environmental	16
Customer Comments	17

Chapter 1: Introduction

Features

- Wireless Digital Input / Relay Output Module Pair
- Each input on one unit is mapped to control the corresponding relay automatically in the other
- 20-mile line of site communications over integrated non-licensed FCC radio modems
- Removable omni-directional antenna without requiring access to inside of enclosure
- 900 MHz unlicensed radio modem with frequency hopping spread spectrum technology
- NEMA4 enclosure for harsh atmospheric or marine environments
- Two water-tight cable glands for power and I/O field wiring
- Inputs accept from 3 to 31V (DC or AC rms) as an “on” signal
- Relays can switch up to 60VDC and up to 125VAC
- Switching current capability up to 0.5A at 125VAC; 1A at 24VDC
- Auto-detection seeks for communications from each other when power applied
- Accepts wide external power input range of 7VDC to 36VDC

Each unit in the pair has the following

- 8 optically-isolated, non-polarized digital inputs
- Jumper-selectable filters per input for electrically noisy environments
- 8 SPDT electromechanical relay outputs
- Internal removable screw terminal boards for simplified wiring

Applications

- Factory Automation
- Energy Management and Conservation
- Agricultural and Irrigation Systems
- Security
- Refinery
- Marinas and Ports
- Lighting

Functional Description

This product features a pair of intelligent 8-bit parallel digital I/O units that communicate with each other without requiring a connection to a PC. Each individual unit is referred to as a WWP-IIRO-8 in the block diagrams. When an input is turned on at one of the units, it will cause the corresponding relay to switch on the other unit. As long as the input stays active, the corresponding relay will remain energized on the other unit. If power is lost to either unit (or communications are interrupted), the other unit will retain the last valid commanded position for the relays. When power is restored to the first unit, any changes that occurred to the eight inputs would then be communicated to the unit that didn't lose power, and the relays would follow the newly reported state.

The units are packaged in NEMA4 enclosures for remote installation in harsh environments. These units act wirelessly, saving time and money associated with wired installations. The units feature 1000mW output radios for communications up to 20 miles line of sight. Alternate antennas may be used to boost signal strength. See Table 1-1 for a list of available and approved antennas.

The 8 isolated inputs can be driven by either AC or DC signals and are not polarity sensitive. Input signals are rectified by photocoupler diodes. Standard 12/24AC control transformer outputs can be accepted as well as DC voltages. The input voltage range is 3 to 31 volts (rms). Unused power dissipates through a 1.8kΩ resistor. External resistors connected in series with this may be used to extend the input voltage range. Each input circuit contains a switchable slow/fast filter that has a 4.7ms time constant. (Without filtering, the response is 10μs) The filter must be selected for AC inputs in order to eliminate response to zero crossings, however, it is also valuable for use with slow DC signals in a noisy environment. A filter is individually selected when a jumper is installed onto any of the positions 'FILTER 0' thru 'FILTER 7'.

A built-in watchdog timer resets the unit if the microcontroller "hangs up".

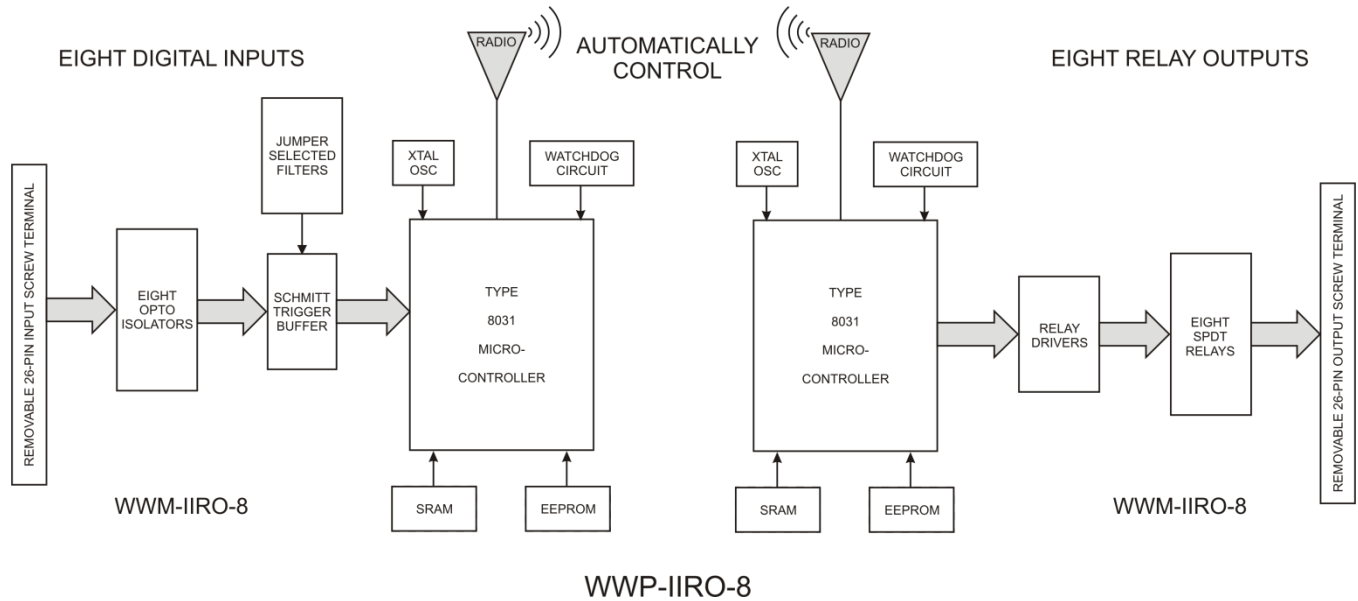

Figure 1-1: Block Diagram Depicting One-Way Signal Flow

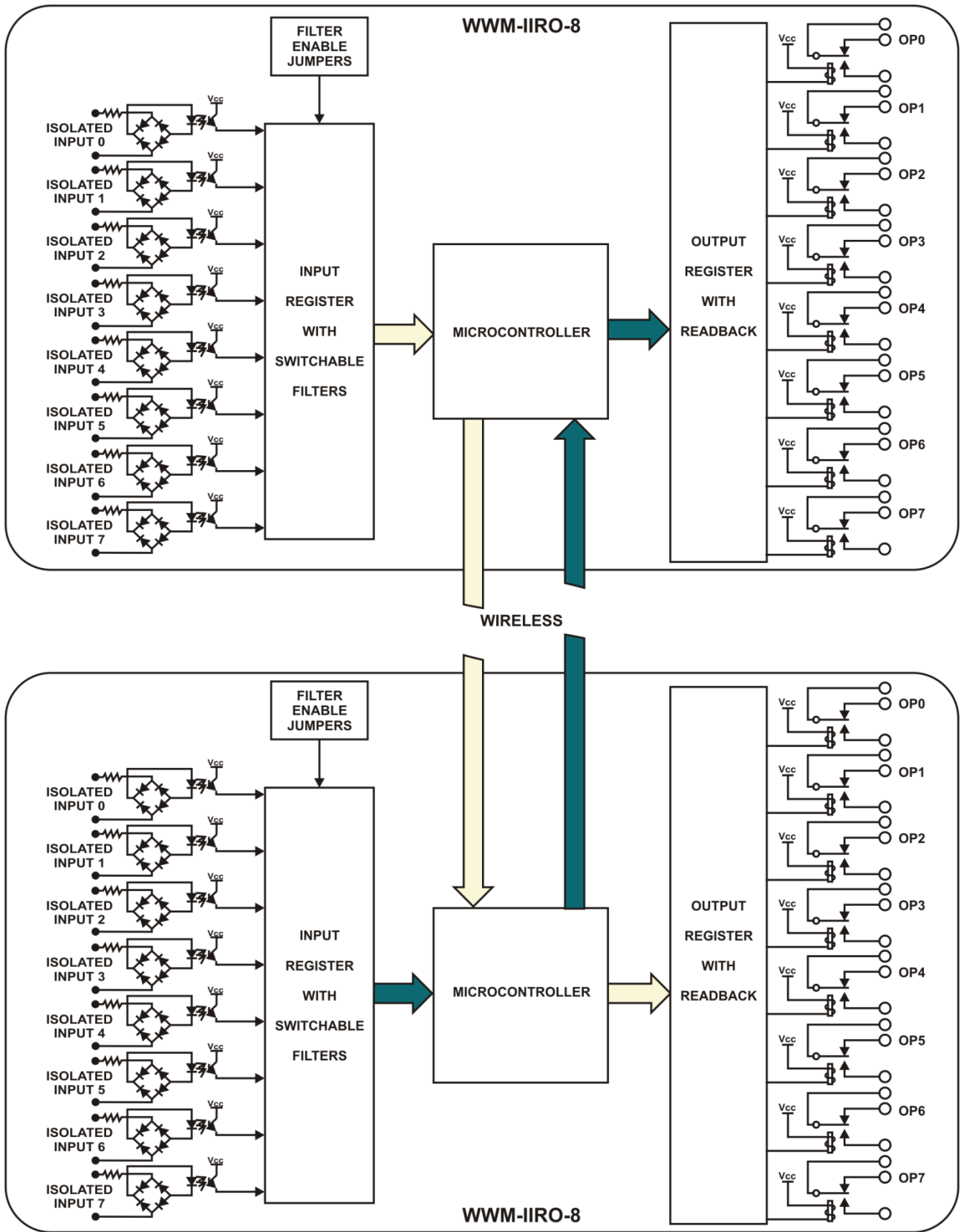

Figure 1-2: Block Diagram Depicting Two-Way (Pair of Units) Signal Flow

Ordering Guide

WWP-IIRO-8	Pair of WWM-IIRO-8's (8 Inputs / 8 Relays, x2)
WWP-II-8/RO-8	One WWM-II-8 paired with one WWM-RO-8 (8 Inputs / 8 Relays)

Model Options

- OEM Boards only (no enclosures)
- HG High gain antenna – (see Table 1-1 for part numbers of available high-gain antennas)
- 24 2.4GHz wireless modules
- T Extended operating temperature of -30°C to +70°C
- S05 3 Second Communications Watchdog Firmware, Relay 7 (Input 7 of each unit not used)
For the –S05 option, Relay 7 in each unit will be energized if communications are good, and de-energized if there is a communications failure or interruption.

Optional Antennas

The following antennas have been approved for use with the radios used in this wireless pair. The user is free to choose another vendor's antenna of like type and equal or lesser gain as a listed antenna and still maintain compliance.

Part Number	Type	Gain (dBi)
0600-00019	½ Wave Dipole	2
0600-00025	½ Wave Dipole	2
0600-00024	½ Wave Dipole	2
0600-00027	½ Wave Dipole	2
0600-00028	½ Wave Dipole	2.5
0600-00029	½ Wave Dipole	2.5
0600-00030	¼ Wave Dipole	1

Table 1-1: Approved Antennas

Pigtail Antenna Extensions

Antenna extension cables can be purchased to allow mounting of the antenna above the roof of a building or to achieve a better line of sight to the other unit of the pair. Available in 10 feet and 20 feet lengths.

Included with your board

The following components are included with your shipment, depending on options ordered. Please take the time now to ensure that no items are damaged or missing.

- Pair of wireless modules in NEMA4 enclosures
- Pair of removable ½ wave directional antennas
- ACCES I/O Master CD (install package for utilities and PDF user manual)

Optional Accessory

PWR-ACDC-9V	<p>“Wall wart” power supply 100-240VAC 50/60Hz to 9VDC with 6’ cable. Stripped and tinned wire termination ready for connection to internal screw terminals.</p>	
-------------	--	---

Chapter 2: Installation

Prior to installing the pair into their final locations, it is recommended you bench test the units side by side to become familiar with their response times, major features and I/O interfaces.

Gain access to the inside of the enclosure by removing the four lid screws, and then set the lid and these screws aside.

This is what you should see:

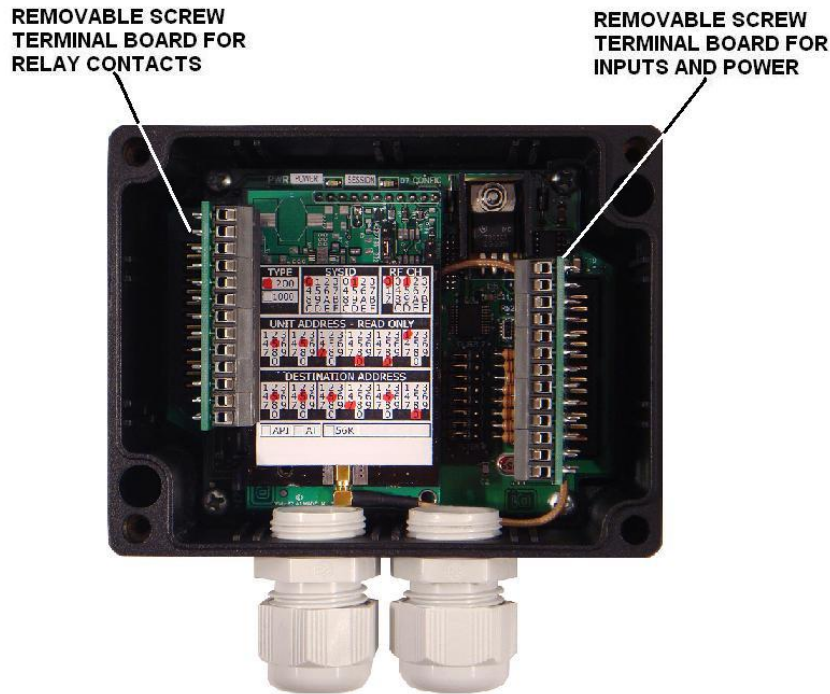



Figure 2-1: Module with the lid open and terminal blocks identified

TYPE	SYSID	RF CH
<input checked="" type="checkbox"/> 200	<input checked="" type="checkbox"/> 1 <input checked="" type="checkbox"/> 2 <input checked="" type="checkbox"/> 3 <input checked="" type="checkbox"/> 0 <input checked="" type="checkbox"/> 2 <input checked="" type="checkbox"/> 3	<input checked="" type="checkbox"/> 0 <input checked="" type="checkbox"/> 2 <input checked="" type="checkbox"/> 3
<input type="checkbox"/> 1000	4 5 6 7 4 5 6 7	1 4 5 6 7
	8 9 A B 8 9 A B	2 8 9 A B
	C D E F C D E F	C D E F



Model #WWP-IIRO-8
Paired Wireless Interface Control Revision C3

8 Relay Outputs
8 Isolated Inputs

UNIT ADDRESS - READ ONLY					
1 2 3	1 2 3	1 2 3	1 2 3	1 2 3	<input checked="" type="checkbox"/> 2 <input checked="" type="checkbox"/> 3
4 <input checked="" type="checkbox"/> 6 4 <input checked="" type="checkbox"/> 6	4 <input checked="" type="checkbox"/> 6 4 <input checked="" type="checkbox"/> 6	4 5 6 4 5 6	4 5 6 4 5 6	4 5 6 4 5 6	4 5 6
7 8 9 7 8 9	7 8 9 <input checked="" type="checkbox"/> 8 9 7 8 9	7 8 9 7 8 9	7 8 9 7 8 9	7 8 9 7 8 9	7 8 9
<input type="checkbox"/> 0	<input type="checkbox"/> 0	<input type="checkbox"/> 0	<input checked="" type="checkbox"/> 0	<input checked="" type="checkbox"/> 0	<input type="checkbox"/> 0

DESTINATION ADDRESS					
1 2 3	1 2 3	1 2 3	1 2 3	1 2 3	1 2 3
4 <input checked="" type="checkbox"/> 6 4 <input checked="" type="checkbox"/> 6	4 <input checked="" type="checkbox"/> 6 4 <input checked="" type="checkbox"/> 6	4 <input checked="" type="checkbox"/> 6 4 <input checked="" type="checkbox"/> 6	4 5 6 4 5 6	4 <input checked="" type="checkbox"/> 6 4 5 6	4 5 6
7 8 9 7 8 9	7 8 9 7 8 9	7 8 9 <input checked="" type="checkbox"/> 8 9 7 8 9	7 8 9 7 8 9	7 8 9 7 8 9	7 8 9
<input type="checkbox"/> 0	<input type="checkbox"/> 0	<input type="checkbox"/> 0	<input type="checkbox"/> 0	<input type="checkbox"/> 0	<input checked="" type="checkbox"/> 0

<input type="checkbox"/> API	<input type="checkbox"/> AT	<input type="checkbox"/> 56K
------------------------------	-----------------------------	------------------------------

FCC ID: KQL-4X90200
IC # 2268C-4X90200

UNIT ADDRESS - READ ONLY					
1 2 3	1 2 3	1 2 3	1 2 3	1 2 3	1 2 3
4 5 6 4 5 6	4 5 6 4 5 6	4 5 6 4 5 6	4 5 6 4 5 6	4 5 6 4 5 6	4 5 6
7 8 9 7 8 9	7 8 9 7 8 9	7 8 9 7 8 9	7 8 9 7 8 9	7 8 9 7 8 9	7 8 9
<input type="checkbox"/> 0	<input type="checkbox"/> 0	<input type="checkbox"/> 0	<input type="checkbox"/> 0	<input type="checkbox"/> 0	<input type="checkbox"/> 0

DESTINATION ADDRESS					
1 2 3	1 2 3	1 2 3	1 2 3	1 2 3	1 2 3
4 5 6 4 5 6	4 5 6 4 5 6	4 5 6 4 5 6	4 5 6 4 5 6	4 5 6 4 5 6	4 5 6
7 8 9 7 8 9	7 8 9 7 8 9	7 8 9 7 8 9	7 8 9 7 8 9	7 8 9 7 8 9	7 8 9
<input type="checkbox"/> 0	<input type="checkbox"/> 0	<input type="checkbox"/> 0	<input type="checkbox"/> 0	<input type="checkbox"/> 0	<input type="checkbox"/> 0

<input type="checkbox"/> 200	<input type="checkbox"/> 1000
<input type="checkbox"/> 56K	
<input type="checkbox"/> API	<input type="checkbox"/> AT

FCC ID: KQL-4X90200 IC # 2268C-4X90200
This device complies with part 15 of the FCC Rules. Operation is subject to the following two conditions: (1) This device may not cause harmful interference, and (2) this device must accept any interference received, including interference that may cause undesired operation.

Figure 2-2: Internal radio label and outer enclosure label examples

Power

If you ordered two of the optional accessory **PWR-ACDC-9V** along with the **WWP-IIRO-8**, they ship with stripped and tinned leads ready for screw terminal connections (+ lead is black with white stripe and yellow or red heat-shrink).

If you didn't order the optional power supply, you'll need to provide a DC power source between 7VDC and 36VDC. Carefully pull up on the input removable screw terminal board to remove it. Route your power supply wires through the gland on the right and make the connections referring to the connector pin assignments in Chapter 5.

Antenna Installation

Thread the directional antenna onto the coaxial connector (RPSMA) on the side of the enclosure until it is snug. Ensure the antenna is tight and does not spin loosely on the coaxial connector as this will affect the integrity of the communications. Thread the second antenna onto the second unit.

Test Setups

There are three scales of test setups from basic to thorough.

Basic Test

Apply power to the unit labeled "Client" (aka "Slave") and observe the green "**PWR**" LED lights up, and the red "**COM**" LED should illuminate brightly when there are no communications. Apply power to the unit labeled as "Server" (aka "Master"), observe the Client's "**COM**" LED should extinguish, indicating communications have been established.

Note: The 2.4GHz option does not behave in this manner. The **COM** LED on both units will blink when there is data being transmitted and received.

Medium Scale Test

This test should consist of a means to control (switch) power to each input independently, thereby providing a means to switch each relay in the other unit. One way to perform this test would be to have eight twisted pairs of wire at least 12 inches with each wire end stripped, then connect each twisted pair to an input. Tighten each screw terminal down onto the stripped wire end until all eight connections are completed, then route the twisted pair bundle through the gland. Re-install the removable terminal block onto the input header. Apply power to both units, then apply a voltage to each input pair one at a time and listen for the relays in the other unit to click, following the input status of the first unit.

Thorough Scale Test

Using an I/O utility accessory with switches, screw terminals and LEDs such as the TAD8-16, you could wire up the power supply return to the "B" side of each input, and the power supply positive to one side of each switch. Connect the other side of each of the eight switches to the "A" side of each input. Then wire the power supply return to the cathode of each of the eight LEDs and connect the power supply positive to the common "C" terminal of each relay. As a final set of connections for the first unit, connect the normally open "NO" contact terminal of each relay to the anode of each LED on the accessory board.

On the second unit, wire up the terminal boards with the power supply positive at each relay common and the power supply return to each “B” input. Then make a one-to-one connection between each NO relay contact and each “A” input.

Power on both units and toggle each switch to perform a “round-trip” test. Each switch that gets toggled into the first unit should control the corresponding relay in the second unit. When the relay in the second unit switches, it will switch power to the input of the second unit, which will then switch the corresponding relay in the first unit.

Verify Wireless Connection

Make sure that the green **PWR** LED is illuminated and that the red **COM** LED is extinguished in each unit.

The signal strength of the antenna can be affected by various things. If possible, mount the units as high as possible within line of sight. If the signal passes from the interior of a building to the interior of another building, installing the units near a window can help maintain signal strength. High gain antennas are also available which can increase the gain up to 11dBi. Consult factory.

Input and Relay Connections

Route all input wiring through the same gland that you routed power. Route all output wiring through the other gland. Make connections per the connector pin assignment table in Chapter 5. Signal arrangements are intuitive on the removable terminal blocks.

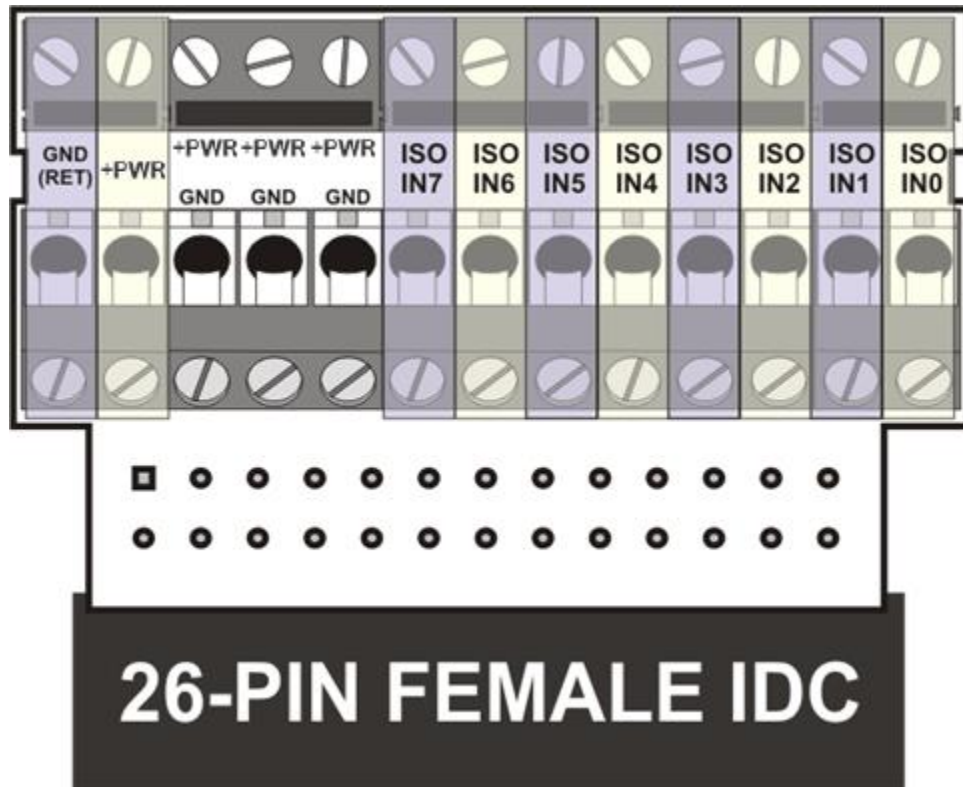

Figure 2-3: Input and power terminal block signal connection locations

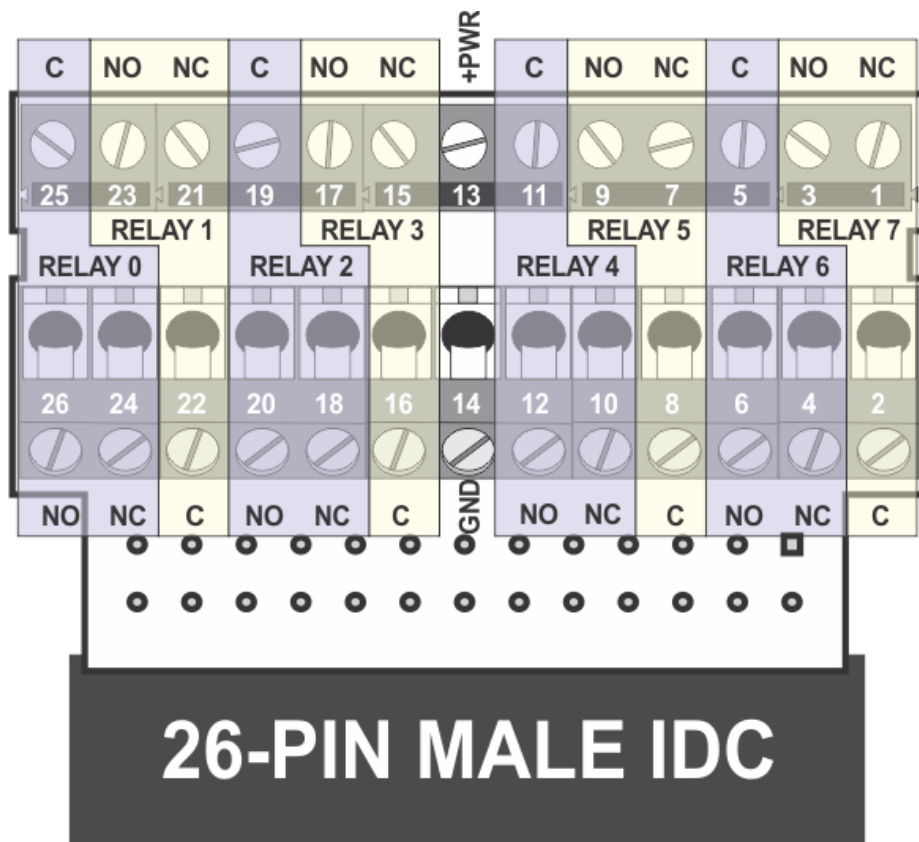

Figure 2-4: Relay terminal block signal arrangements

Chapter 3: Hardware Details

Option Selections

Filter Response Jumpers

Jumpers are used to select input filtering on a channel-by-channel basis. When jumper FLT0 is installed, additional filtering is introduced for input bit 0, FLT1 for bit 1, etc. This additional filtering must be used when AC inputs are applied. (applicable for 900MHz modules, for 2.4GHz, PWR blinks when the unit is transmitting and COM blinks when the unit is receiving.)

COM LED
 ON (Client / Slave): NO COMMUNICATION
 OFF: COMMUNICATION GOOD

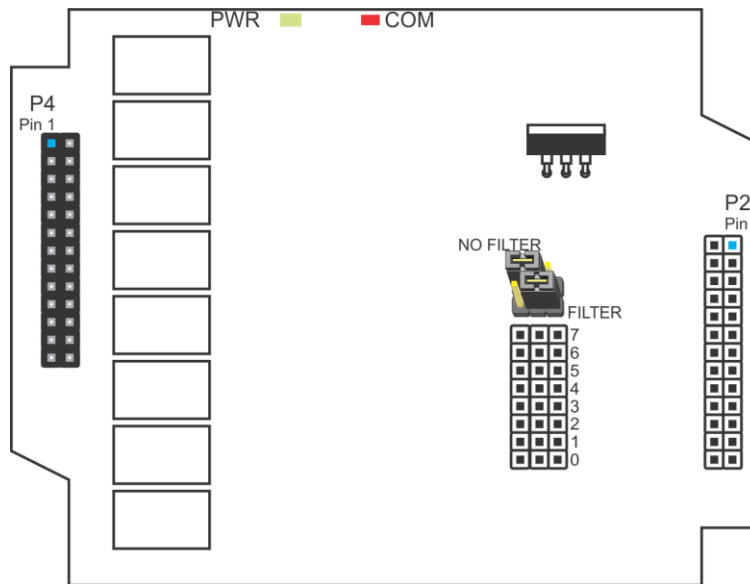

Figure 3-1: Option Selection Map

JUMPER SELECTION	Bit Filtered
FLT-0	IN00
FLT-1	IN01
FLT-2	IN02
FLT-3	IN03
FLT-4	IN04
FLT-5	IN05
FLT-6	IN06
FLT-7	IN07

Table 3-1: Input Filter Jumper Selections

Chapter 4: Connector Pin Assignments

'Isolated Input' P2 Terminal Block	Signal	'Relay Output' P4 Terminal Block	Signal
1	GND	1	Relay 7 - normally closed
2	GND	2	Relay 7 - common
3	+PWR	3	Relay 7 - normally open
4	+PWR	4	Relay 6 - normally closed
5	+PWR	5	Relay 6 - common
6	GND	6	Relay 6 - normally open
7	+PWR	7	Relay 5 - normally closed
8	GND	8	Relay 5 - common
9	+PWR	9	Relay 5 - normally open
10	GND	10	Relay 4 - normally closed
11	Isolated Input 7 B	11	Relay 4 - common
12	Isolated Input 7 A	12	Relay 4 - normally open
13	Isolated Input 6 B	13	+PWR
14	Isolated Input 6 A	14	GND
15	Isolated Input 5 B	15	Relay 3 - normally closed
16	Isolated Input 5 A	16	Relay 3 - common
17	Isolated Input 4 B	17	Relay 3 - normally open
18	Isolated Input 4 A	18	Relay 2 - normally closed
19	Isolated Input 3 B	19	Relay 2 - common
20	Isolated Input 3 A	20	Relay 2 - normally open
21	Isolated Input 2 B	21	Relay 1 - normally closed
22	Isolated Input 2 A	22	Relay 1 - common
23	Isolated Input 1 B	23	Relay 1 - normally open
24	Isolated Input 1 A	24	Relay 0 - normally closed
25	Isolated Input 0 B	25	Relay 0 - common
26	Isolated Input 0 A	26	Relay 0 - normally open

Table 4-1: Screw Terminal Connections

Chapter 5: Specifications

General

- Intelligence: Type 8051 microcontroller family
- Protection: Watchdog Timer circuit
- Size of NEMA4 box: 4.53" long by 3.54" wide by 2.17" high
- Weight: 19.0 oz
- Throughput: Typical 15Hz, Worst case 10Hz

Power Requirements

- Voltage: 7 to 36 VDC
- Current: 130 mA – nominal, measured during normal operations in which both units are communicating with each other.
30 mA - increase per relay activation
470 mA - maximum (all relays energized)

900 MHz Radio

- Frequency Range: 902 to 928 MHz, Unlicensed ISM Band
- Type: Frequency Hopping Spread Spectrum Transceiver
- Transmit Power: 1000mW
- Receiver Sensitivity: -110dBm
- Outdoor Range: 20 miles (theoretical with line of sight and high-gain antenna)
- Interference Rejection: 70dB at pager and cellular phone frequencies
- RF Data Rate: 76.8kbps
- Interface Buffer Size: 256 bytes each

900 MHz Antenna

- Frequency Range: 902 to 928 MHz
- Impedance: 50 Ω nominal
- Gain: 2.1 dBi
- Length: 7"
- Polarization: Vertical
- Wave: Half Wave
- Connector: SMA reverse polarity plug (RPSMA)

Isolated Inputs

- Number: Eight
- Type: Non-polarized, optically isolated from each other and from the computer (CMOS compatible)
- Logic Input Low: -0.5 V to 0.8 V
- Logic Input High: +3.0 V to +31.0 V
- Isolation: 60V channel-to-ground or channel-to-channel
- Input Resistance: 1.8K ohms in series with two diodes and an LED

Relay Outputs

- Number: Eight
- Contact Form: SPDT (form C)
- Contact Type: Single Crossbar
- Contact Material: Silver + Gold-clad
- Rated Load: 0.5A at 125VAC; 1A at 24VDC
- Max. Switching Current: 1A
- Max. Switching Voltage: 125VAC; 60VDC
- Max. Switching Capacity: 62.5VA; 30W
- Contact Resistance: 100mΩ max.
- Operate Time: 5ms
- Release Time: 5ms
- Contact Life (mechanical): 5 million operations

Environmental

- Operating Temperature Range: 0°C to 70°C (-30°C to +70°C optional)
- Storage Temperature Range: -20 °C. to +70 °C.
- Humidity: 5% to 95% RH non-condensing.

Customer Comments

If you experience any problems with this manual or just want to give us some feedback, please email us at: ***manuals@accessio.com***. Please detail any errors you find and include your mailing address so that we can send you any manual updates.

