



10623 Roselle Street, San Diego, CA 92121 • (858) 550-9559 • Fax (858) 550-7322
contactus@accesio.com • www.accesio.com

MODELS
USB-IDIO-16L
USB-IDO-16L
USB-IDIO-8L

ISOLATED DIGITAL INPUT
LOW-SIDE FET SWITCH
OUTPUT BOARDS

USER MANUAL

File: MUSB-IDIO-16L.B1c

Notice

The information in this document is provided for reference only. ACCES does not assume any liability arising out of the application or use of the information or products described herein. This document may contain or reference information and products protected by copyrights or patents and does not convey any license under the patent rights of ACCES, nor the rights of others.

IBM PC, PC/XT, and PC/AT are registered trademarks of the International Business Machines Corporation.

Printed in USA. Copyright 2008 by ACCES I/O Products, Inc. 10623 Roselle Street, San Diego, CA 92121. All rights reserved.

WARNING!!

ALWAYS CONNECT AND DISCONNECT YOUR FIELD CABLING WITH THE COMPUTER POWER OFF. ALWAYS TURN COMPUTER POWER OFF BEFORE INSTALLING A BOARD. CONNECTING AND DISCONNECTING CABLES, OR INSTALLING BOARDS INTO A SYSTEM WITH THE COMPUTER OR FIELD POWER ON MAY CAUSE DAMAGE TO THE I/O BOARD AND WILL VOID ALL WARRANTIES, IMPLIED OR EXPRESSED.

Warranty

Prior to shipment, ACCES equipment is thoroughly inspected and tested to applicable specifications. However, should equipment failure occur, ACCES assures its customers that prompt service and support will be available. All equipment originally manufactured by ACCES which is found to be defective will be repaired or replaced subject to the following considerations.

Terms and Conditions

If a unit is suspected of failure, contact ACCES' Customer Service department. Be prepared to give the unit model number, serial number, and a description of the failure symptom(s). We may suggest some simple tests to confirm the failure. We will assign a Return Material Authorization (RMA) number which must appear on the outer label of the return package. All units/components should be properly packed for handling and returned with freight prepaid to the ACCES designated Service Center, and will be returned to the customer's/user's site freight prepaid and invoiced.

Coverage

First Three Years: Returned unit/part will be repaired and/or replaced at ACCES option with no charge for labor or parts not excluded by warranty. Warranty commences with equipment shipment.

Following Years: Throughout your equipment's lifetime, ACCES stands ready to provide on-site or in-plant service at reasonable rates similar to those of other manufacturers in the industry.

Equipment Not Manufactured by ACCES

Equipment provided but not manufactured by ACCES is warranted and will be repaired according to the terms and conditions of the respective equipment manufacturer's warranty.

General

Under this Warranty, liability of ACCES is limited to replacing, repairing or issuing credit (at ACCES discretion) for any products which are proved to be defective during the warranty period. In no case is ACCES liable for consequential or special damage arriving from use or misuse of our product. The customer is responsible for all charges caused by modifications or additions to ACCES equipment not approved in writing by ACCES or, if in ACCES opinion the equipment has been subjected to abnormal use. "Abnormal use" for purposes of this warranty is defined as any use to which the equipment is exposed other than that use specified or intended as evidenced by purchase or sales representation. Other than the above, no other warranty, expressed or implied, shall apply to any and all such equipment furnished or sold by ACCES.

TABLE OF CONTENTS

Chapter 1: Introduction	5
Features	5
Applications	5
Inputs	5
Outputs	5
Screw Terminal Accessory Board	6
USB Connector	6
LED	6
Figure 1-1: Block Diagram	6
Figure 1-2: Example of One Input Circuit	7
Figure 1-3: Example of One Output Circuit	7
Ordering Guide	7
Model Options	7
Accessories	7
Included with your board	7
Chapter 2: Installation	8
Software CD Installation	8
WIN98/Me/2000/XP/2003	8
Hardware Installation	8
Chapter 3: Option Selection	9
External Power	9
Filter Response Jumpers	9
Figure 3-1: Option Selection Map	10
Chapter 4: USB Address Information	11
Chapter 5: Programming	12
Chapter 6: Connector Pin Assignments	13
Figure 6-1: FET Output Pin Assignments (P3)	13
Figure 6-2: Isolated Input Pin Assignments (P2)	14
Figure 6-3: USB-STB-84 Screw Terminal Board	15
Chapter 7: Specification	16
Isolated Inputs	16
Isolated FET Outputs	16
Power Required	16
Environmental	17
Customer Comments	18

Chapter 1: Introduction

This 32 channel optically isolated digital I/O board is an ideal solution for adding portable, easy-to-install industrial grade I/O to any computer with a supported USB port. As a USB 2.0 high speed device it offers the fastest speed currently available with the USB bus, while being fully compatible with both USB 1.1 and USB 2.0 ports. The card is plug-and-play allowing for quick connect/disconnect whenever you need additional I/O on your computer.

Features

- High Speed USB 2.0 device, USB 1.1 compatible
- 16 optically-isolated inputs
- 16 fully protected and isolated low-side FET 0.5A outputs
- Custom high-speed function driver
- Internal, removable screw terminal board for easy wiring
- Small (4" x 4" x 1.4") rugged industrial enclosure
- PC/104 module size and mounting compatibility

Applications

These boards are especially useful in applications where high common-mode external voltages are present. Isolation is required to guard electronics from transient voltage spikes and offers greater common-mode noise rejection in electronically noisy surroundings containing industrial machinery and inductive loads. These applications include factory automation, energy management, industrial ON/OFF control, security systems, manufacturing test, and process monitoring. In addition to protecting industrial applications from accidental contact with high external voltages, the isolation provided eliminates troublesome ground loops.

Inputs

The board provides sixteen optically-isolated inputs. These inputs can accept either AC or DC signals and are not polarity sensitive. Input signals are rectified by photocoupler diodes while unused power gets dissipated through a 1.8k-ohm resistor in series. The inputs may be driven by either DC sources of 3 to 31 volts or AC (RMS) sources at frequencies of 40 Hz to 10 kHz. Standard 12/24 AC control transformer outputs can be accepted as well. External resistors connected in series may be used to extend the input voltage range, however this will raise the input threshold range. Consult with factory for available modified input ranges.

Each input circuit contains a switchable filter that has a 4.7 millisecond time constant. (Without filtering, the response is less than 40 microseconds.) The filter must be selected for AC inputs in order to eliminate the on/off response to zero crossings of the AC. The filter is also valuable for use with slow DC input signals in a noisy environment. The filter may be switched out for DC inputs in order to obtain faster response. Filters are individually selected by jumpers. The filters are switched into the circuit when the jumpers are installed in position FLT0 to FLT15.

Outputs

The low-side switch solid state outputs are comprised of sixteen fully protected and isolated FET outputs. The FET's have built in current limiting and are protected against short-circuit, over-temperature, ESD and inductive load transients. The current limitation is activated until the thermal protection acts. The FET's are all off at power-on.

Screw Terminal Accessory Board

A Screw Terminal Accessory board is included with the unit, except for the Economy (E) and OEM versions. The board provides access to all I/O signals via a removable spring cage terminal board. Signal names are clearly marked on a label for the low side FET output terminals, and on the silk screen for the input signals. The screw terminal board plugs directly onto the I/O board while fitting inside the rugged industrial enclosure.

USB Connector

A type B USB connector is used on all models which features a high retention design that complies with the class 1, Div II minimum withdrawal requirement of over 3 pounds of force. This connector has an orange color-coded insulator to differentiate it from standard USB connectors. The USB port provides communication signals along with +5 VDC power. The board can be powered from the USB port or, if needed for higher current applications, an external power supply can be used.

LED

The LED on the front of the enclosure is used to indicate power and data transmissions. When the LED is in an illuminated steady green state, this signifies that the board is successfully connected to the computer and has been detected and configured by the operating system. When the LED flashes continuously, this signifies that there is data being transmitted over the USB bus.

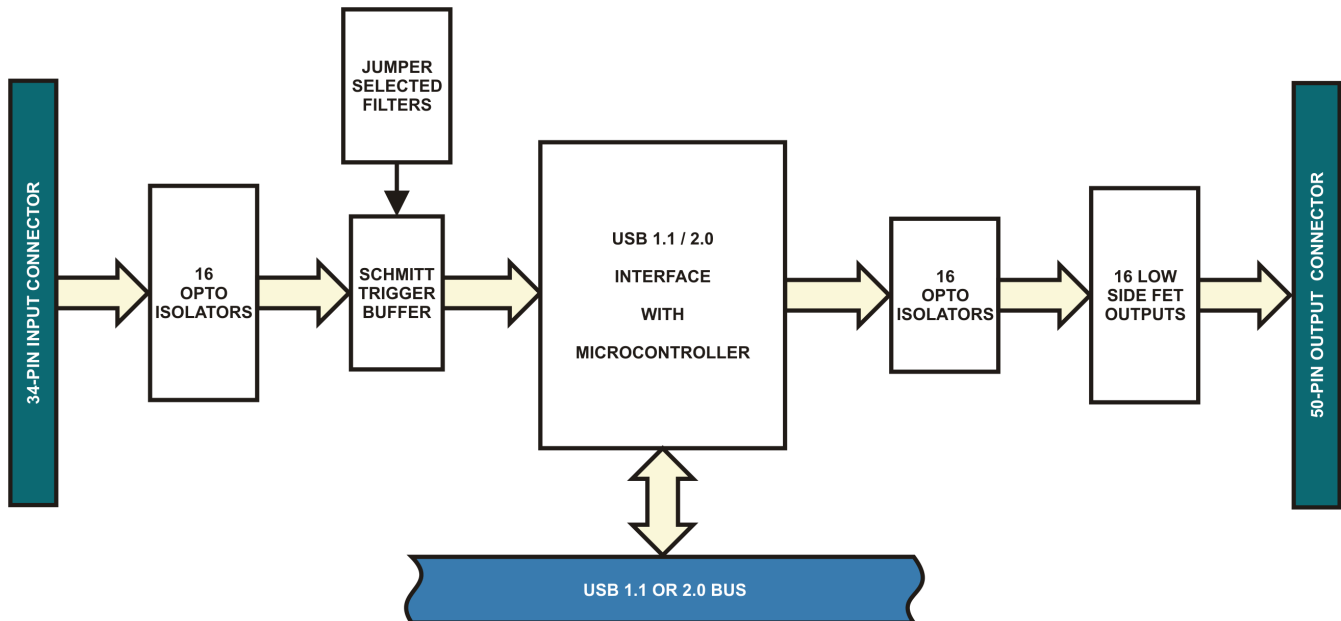

Figure 1-1: Block Diagram

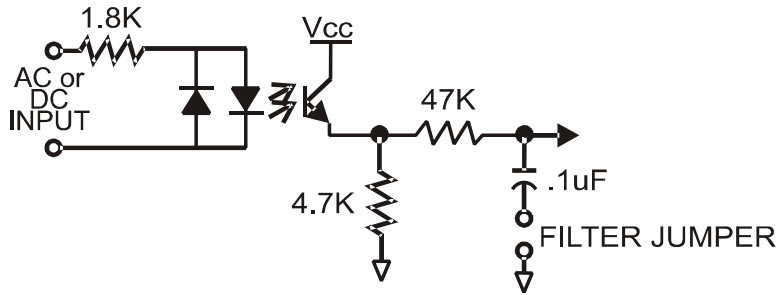

Figure 1-2: Example of One Input Circuit

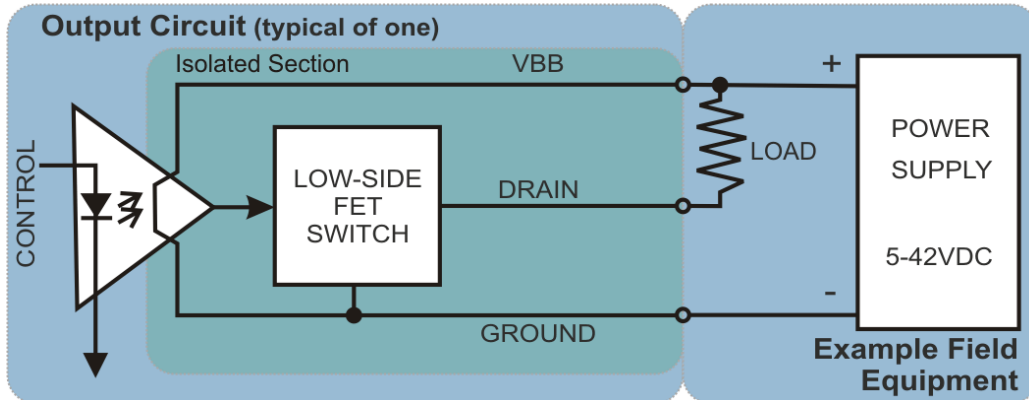

Figure 1-3: Example of One Output Circuit

Ordering Guide

USB-IDIO-16L	Enclosure, module and screw terminal board
USB-IDO-16L	16 isolated FET solid state outputs only version
USB-IDIO-8L	8 isolated digital inputs and 8 isolated FET solid state outputs version

Model Options

-OEM	Board only version (no enclosure and screw terminal board)
-E	Economy model (no screw terminal board)
-DIN	DIN rail mounting provision
-P	External power and AC/DC adapter

Accessories

USB-STB-84-16L	Internal plug in spring cage terminal board
----------------	---

Included with your board

The following components are included with your shipment depending on options ordered. Please take time now to ensure that no items are damaged or missing.

1. USB-Isolated Input/Low Side FET Output Board (unit installed in labeled enclosure with USB-STB-84-xxL installed)
2. 6' USB cable

Chapter 2: Installation

Software Installation

The software provided with this board is must be downloaded from the product page at <https://accessio.com/?p=/usb/usb-idio-16l.html> then installed onto your system.

Hardware Installation

The board can be installed in any USB 2.0 or USB 1.1 port.

Chapter 3: Option Selection

Refer to the settings program installed with your software package for the board. Also, refer to the Block Diagram and the Option Selection Map when reading this section of the manual.

External Power

This is an option for *rare* applications that use more current than what your computer can provide on the USB port (typically 500 mA). The DC jack has a 2.00mm post on board and is designed to be used with the 9 VDC AC/DC external power supply that ships with this option. The voltage regulator on board regulates the 9 VDC and provides 5 VDC to the onboard circuitry. When using external power, switch the jumper located near the USB connector to VEXT, otherwise when the jumper is in the VUSB position current is drawn from the USB port.

Filter Response Jumpers

Jumpers are used to select input filtering on a channel-by-channel basis. When jumper FLT0 is installed, additional filtering is introduced for input bit 0, FLT1 for bit 1, etc.

JUMPER SELECTION	Bit Filtered
FLT-0	IN00
FLT-1	IN01
FLT-2	IN02
FLT-3	IN03
FLT-4	IN04
FLT-5	IN05
FLT-6	IN06
FLT-7	IN07

JUMPER SELECTION	Bit Filtered
FLT-8	IN08
FLT-9	IN09
FLT-10	IN10
FLT-11	IN11
FLT-12	IN12
FLT-13	IN13
FLT-14	IN14
FLT-15	IN15

This additional filtering provides a slower response for DC signals as described previously and must be used when AC inputs are applied.

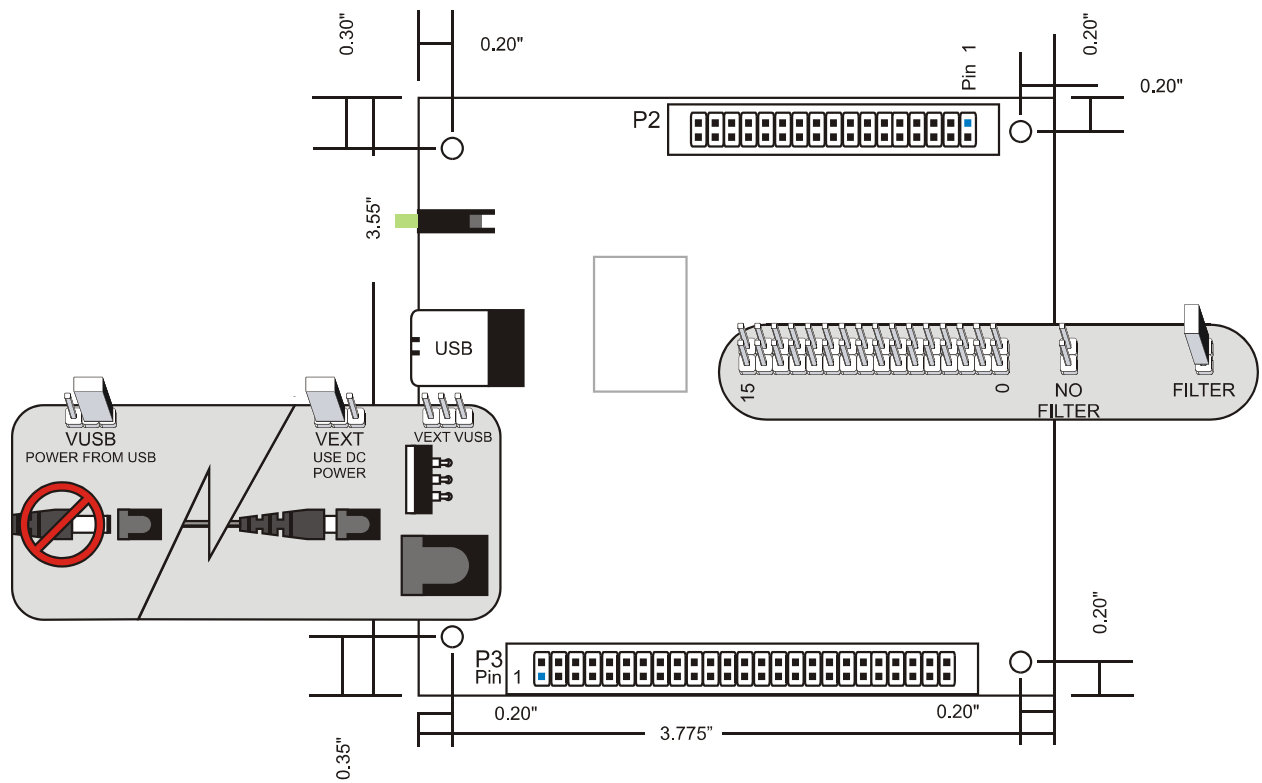

Figure 3-1: Option Selection Map

Chapter 4: USB Address Information

Use the provided driver to access the USB board. This driver will allow you to determine how many supported USB devices are currently installed, and each device's type. This information is returned as a Vendor ID (VID), Product ID (PID) and Device Index.

The board's VID is "0x1605", and its PID is "0x8018".

The Device Index is determined by how many of the device you have in your system, and provides a unique identifier allowing you to access a specific board at will.

Chapter 5: Programming

The driver software provided with the board uses a 32-bit .dll front end compatible with any Windows programming language. Samples provided in Borland C++Builder, Borland Delphi, Microsoft Visual Basic, and Microsoft Visual C++ demonstrate the use of the driver.

The following functions are provided by the driver in Windows.

These functions will allow you to read or write individual bits, bytes, or the entire board worth of data. In addition, counter-timer functionality and board-level functions complete the driver package.

For detailed information on each function refer to the .html Driver Manual located in the Win32 directory for this board.

```
unsigned long GetDevices(void )
unsigned long QueryDeviceInfo(DeviceIndex, pPID, pName, pDIOBytes, pCounters)
unsigned long DIO_Configure(DeviceIndex, bTristate, pOutMask, pData)
unsigned long DIO_Write1(DeviceIndex, BitIndex, bData)
unsigned long DIO_Write8(DeviceIndex, ByteIndex, Data)
unsigned long DIO_WriteAll(DeviceIndex,pData)
unsigned long DIO_Read8(DeviceIndex, ByteIndex,pBuffer)
unsigned long DIO_ReadAll(DeviceIndex,Buffer)
```

Chapter 6: Connector Pin Assignments



FET outputs are connected to the board via a 50-pin HEADER type connector named P3. The mating connector is an IDC type with 0.1 inch centers or equivalent. Keep in mind that standard ribbon cables usually limit current to 300mA per conductor, which is less than the FETs are able to switch. Normally, a screw terminal accessory (USB-STB-84) is included and installed directly on to the board headers.

PIN	NAME	FUNCTION
1	OUT15VBB	Bit 15 Power Supply Voltage
2	OUT15LOAD	Bit 15 Load Connection
3	OUT15GND	Bit 15 Power Supply Return (or Ground)
4	OUT14VBB	Bit 14 Power Supply Voltage
5	OUT14LOAD	Bit 14 Load Connection
6	OUT14GND	Bit 14 Power Supply Return (or Ground)
7	OUT13VBB	Bit 13 Power Supply Voltage
8	OUT13LOAD	Bit 13 Load Connection
9	OUT13GND	Bit 13 Power Supply Return (or Ground)
10	OUT12VBB	Bit 12 Power Supply Voltage
11	OUT12LOAD	Bit 12 Load Connection
12	OUT12GND	Bit 12 Power Supply Return (or Ground)
13	OUT11VBB	Bit 11 Power Supply Voltage
14	OUT11LOAD	Bit 11 Load Connection
15	OUT11GND	Bit 11 Power Supply Return (or Ground)
16	OUT10VBB	Bit 10 Power Supply Voltage
17	OUT10LOAD	Bit 10 Load Connection
18	OUT10GND	Bit 10 Power Supply Return (or Ground)
19	OUT09VBB	Bit 09 Power Supply Voltage
20	OUT09LOAD	Bit 09 Load Connection
21	OUT09GND	Bit 09 Power Supply Return (or Ground)
22	OUT08VBB	Bit 08 Power Supply Voltage
23	OUT08LOAD	Bit 08 Load Connection
24	OUT08GND	Bit 08 Power Supply Return (or Ground)
25		
26		
27	OUT07GND	Bit 07 Power Supply Return (or Ground)
28	OUT07LOAD	Bit 07 Load Connection
29	OUT07VBB	Bit 07 Power Supply Voltage
30	OUT06GND	Bit 06 Power Supply Return (or Ground)
31	OUT06LOAD	Bit 06 Load Connection
32	OUT06VBB	Bit 06 Power Supply Voltage
33	OUT05GND	Bit 05 Power Supply Return (or Ground)
34	OUT05LOAD	Bit 05 Load Connection
35	OUT05VBB	Bit 05 Power Supply Voltage
36	OUT04GND	Bit 04 Power Supply Return (or Ground)
37	OUT04LOAD	Bit 04 Load Connection
38	OUT04VBB	Bit 04 Power Supply Voltage
39	OUT03GND	Bit 03 Power Supply Return (or Ground)
40	OUT03LOAD	Bit 03 Load Connection
41	OUT03VBB	Bit 03 Power Supply Voltage
42	OUT02GND	Bit 02 Power Supply Return (or Ground)
43	OUT02LOAD	Bit 02 Load Connection
44	OUT02VBB	Bit 02 Power Supply Voltage
45	OUT01GND	Bit 01 Power Supply Return (or Ground)
46	OUT01LOAD	Bit 01 Load Connection
47	OUT01VBB	Bit 01 Power Supply Voltage
48	OUT00GND	Bit 00 Power Supply Return (or Ground)
49	OUT00LOAD	Bit 00 Load Connection
50	OUT00VBB	Bit 00 Power Supply Voltage

Figure 6-1: FET Output Pin Assignments (P3)

Isolated Inputs are connected to the board via a 34-pin HEADER type connector named P2. The mating connector is an IDC type with 0.1 inch centers or equivalent.

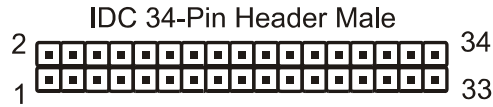

PI N	NAME	FUNCTION
1	IN00 A	Isolated Input 00 A
2	IN00 B	Isolated Input 00 B
3	IN01 A	Isolated Input 01 A
4	IN01 B	Isolated Input 01 B
5	IN02 A	Isolated Input 02 A
6	IN02 B	Isolated Input 02 B
7	IN03 A	Isolated Input 03 A
8	IN03 B	Isolated Input 03 B
9	IN04 A	Isolated Input 04 A
10	IN04 B	Isolated Input 04 B
11	IN05 A	Isolated Input 05 A
12	IN05 B	Isolated Input 05 B
13	IN06 A	Isolated Input 06 A
14	IN06 B	Isolated Input 06 B
15	IN07 A	Isolated Input 07 A
16	IN07 B	Isolated Input 07 B
17		
18		
19	IN08 A	Isolated Input 08 A
20	IN08 B	Isolated Input 08 B
21	IN09 A	Isolated Input 09 A
22	IN09 B	Isolated Input 09 B
23	IN10 A	Isolated Input 10 A
24	IN10 B	Isolated Input 10 B
25	IN11 A	Isolated Input 11 A
26	IN11 B	Isolated Input 11 B
27	IN12 A	Isolated Input 12 A
28	IN12 B	Isolated Input 12 B
29	IN13 A	Isolated Input 13 A
30	IN13 B	Isolated Input 13 B
31	IN14 A	Isolated Input 14 A
32	IN14 B	Isolated Input 14 B
33	IN15 A	Isolated Input 15 A
34	IN15 B	Isolated Input 15 B

Figure 6-2: Isolated Input Pin Assignments (P2)

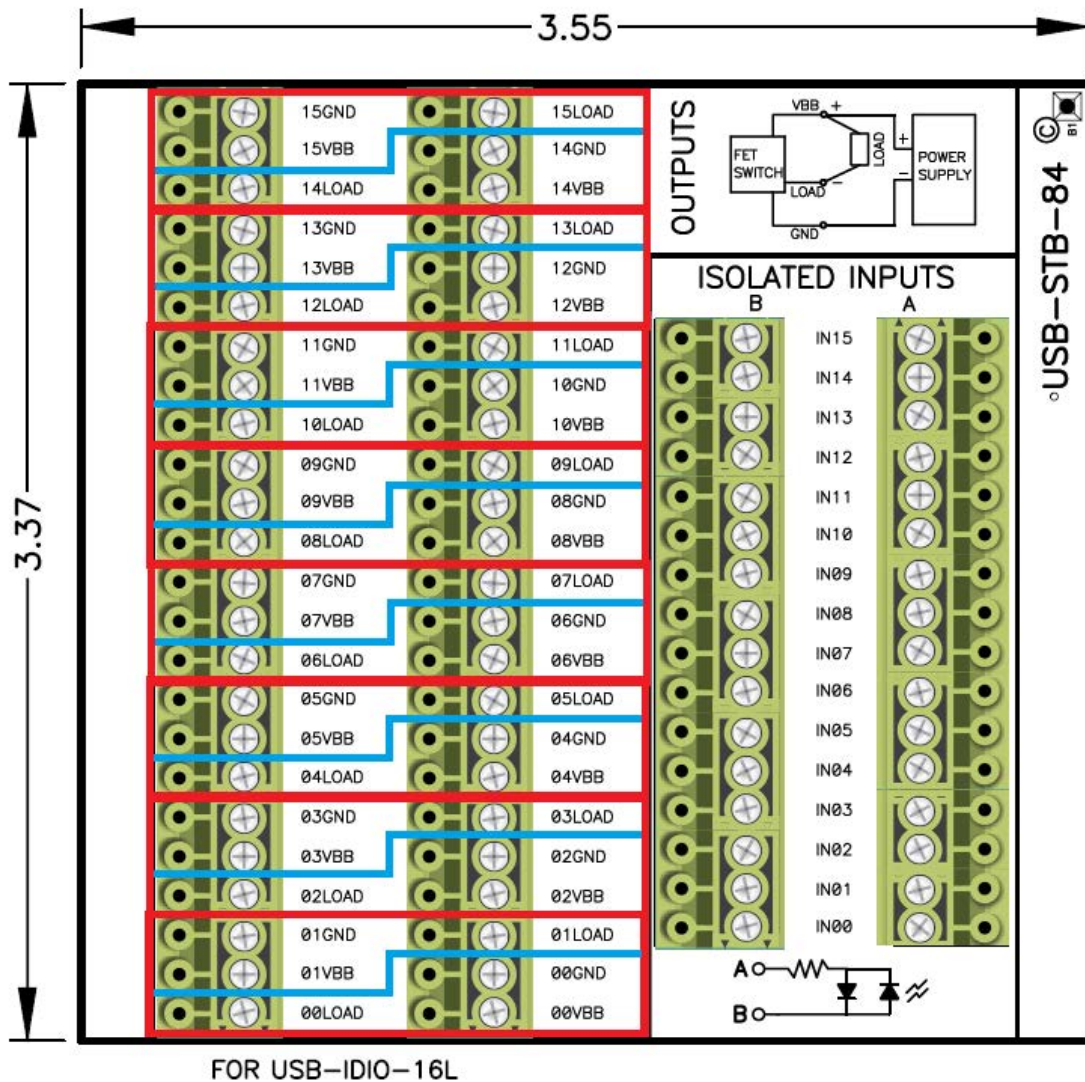

Figure 6-3: USB-STB-84 Screw Terminal Board

Chapter 7: Specification

Isolated Inputs

Number of inputs:	Sixteen
Type:	Non-polarized, optically isolated from each other and from the computer (CMOS compatible)
Voltage Range:	3 to 31 DC or AC RMS (40 Hz to 10 kHz)
Isolation:	500V*(see note) channel-to-ground or channel-to channel
Input Resistance:	1.8K ohms in series with opto coupler
Filter Response:	Rise Time = 4.7 mS / Fall Time = 4.7 mS
Non-Filter Response:	Rise Time = 10 uS / Fall Time = 30 Us
Connector:	34 pin vertical dual-row header with 0.1" spacing

Isolated FET Outputs

Number of outputs:	Sixteen Solid State FET's (off @ power up)
Output Type:	Smart Low Side Power HITFET Switch. Protected against short circuit, over-temperature, ESD, and can drive all types of resistive, inductive and capacitive loads.
Voltage Range:	2-42VDC recommended (customer supplied) for continuous use.
Current Rating:	0.5A maximum
Turn-on time:	16 uS (typical)
Turn-off time:	15 uS (typical)
Connector:	50 pin vertical dual-row header with 0.1" spacing

Power Required

5V @ 35mA typical (all FETs off, add 5mA per FET)

5V @ 115mA typical (all FETs on)

+5VDC provided via USB cable up to 500mA**

**optional external power supply can be ordered if desired if current use of the board is expected to be greater than what can be supplied by the USB cable.

Environmental

Operating Temp: 0 - 70 °C (Non-icing)

*Notes on Isolation:

Opto-Isolators and connectors are rated for at least 500V, but isolation voltage breakdowns will vary and is affected by factors like cabling, spacing of pins, spacing between traces on the PCB, humidity, dust and other environmental factors. This is a safety issue so a careful approach is required. For CE certification on the front end of the circuitry, isolation was specified at 40V AC and 60V DC. The design intention was to eliminate the influence of common mode. Use proper wiring techniques to minimize voltage between channels and to ground. For example, when working with AC voltages do not connect the hot side of the line to an input. Tolerance of higher isolation voltage can be obtained on request by applying a conformal coating to the board.

Customer Comments

If you experience any problems with this manual or just want to give us some feedback, please email us at: ***manuals@acesio.com***. Please detail any errors you find and include your mailing address so that we can send you any manual updates.



10623 Roselle Street, San Diego CA 92121
Tel. (858)550-9559 FAX (858)550-7322
www.acesio.com