



10623 Roselle Street, San Diego, CA 92121 • (858) 550-9559 • FAX (858) 550-7322  
contactus@accessio.com • www.accessio.com

## **MODEL USB-DIO-32I**

# **32-Channel, Individual, Independently Selectable Digital I/O Module**

## **USER MANUAL**

## Notice

The information in this document is provided for reference only. ACCES does not assume any liability arising out of the application or use of the information or products described herein. This document may contain or reference information and products protected by copyrights or patents and does not convey any license under the patent rights of ACCES, nor the rights of others.

IBM PC, PC/XT, and PC/AT are registered trademarks of the International Business Machines Corporation.

Printed in USA. Copyright 2011 by ACCES I/O Products Inc, 10623 Roselle Street, San Diego, CA 92121. All rights reserved.

## WARNING!!

**ALWAYS CONNECT AND DISCONNECT YOUR FIELD CABLING WITH THE COMPUTER POWER OFF. ALWAYS TURN COMPUTER POWER OFF BEFORE INSTALLING A CARD. CONNECTING AND DISCONNECTING CABLES, OR INSTALLING CARDS INTO A SYSTEM WITH THE COMPUTER OR FIELD POWER ON MAY CAUSE DAMAGE TO THE I/O CARD AND WILL VOID ALL WARRANTIES, IMPLIED OR EXPRESSED.**

## **Warranty**

Prior to shipment, ACCES equipment is thoroughly inspected and tested to applicable specifications. However, should equipment failure occur, ACCES assures its customers that prompt service and support will be available. All equipment originally manufactured by ACCES which is found to be defective will be repaired or replaced subject to the following considerations.

### **Terms and Conditions**

If a unit is suspected of failure, contact ACCES' Customer Service department. Be prepared to give the unit model number, serial number, and a description of the failure symptom(s). We may suggest some simple tests to confirm the failure. We will assign a Return Material Authorization (RMA) number which must appear on the outer label of the return package. All units/components should be properly packed for handling and returned with freight prepaid to the ACCES designated Service Center, and will be returned to the customer's/user's site freight prepaid and invoiced.

### **Coverage**

First Three Years: Returned unit/part will be repaired and/or replaced at ACCES option with no charge for labor or parts not excluded by warranty. Warranty commences with equipment shipment.

Following Years: Throughout your equipment's lifetime, ACCES stands ready to provide on-site or in-plant service at reasonable rates similar to those of other manufacturers in the industry.

### **Equipment Not Manufactured by ACCES**

Equipment provided but not manufactured by ACCES is warranted and will be repaired according to the terms and conditions of the respective equipment manufacturer's warranty.

### **General**

Under this Warranty, liability of ACCES is limited to replacing, repairing or issuing credit (at ACCES discretion) for any products which are proved to be defective during the warranty period. In no case is ACCES liable for consequential or special damage arriving from use or misuse of our product. The customer is responsible for all charges caused by modifications or additions to ACCES equipment not approved in writing by ACCES or, if in ACCES opinion the equipment has been subjected to abnormal use. "Abnormal use" for purposes of this warranty is defined as any use to which the equipment is exposed other than that use specified or intended as evidenced by purchase or sales representation. Other than the above, no other warranty, expressed or implied, shall apply to any and all such equipment furnished or sold by ACCES.

### **Support and Application Engineering**

ACCES stands behind our products and strive to provide responsive support and service. If you need help working with our products, or customization advice, please don't hesitate to call us at 800-326-1649. Your utter satisfaction is our ultimate reward!

## Table of Contents

Warranty .....	3
Terms and Conditions .....	3
Coverage .....	3
Equipment Not Manufactured by ACCES .....	3
General .....	3
Support and Application Engineering .....	3
Chapter 1: Introduction .....	5
Features .....	5
Applications .....	5
Functional Description .....	6
Figure 1-1: Block Diagram .....	7
Ordering Guide .....	7
Model Options .....	7
Special Order .....	7
Customization and Special Functions .....	7
Figure 1-2: Enclosure Label .....	9
Chapter 2: Installation .....	10
Software CD Installation .....	10
Hardware Installation .....	10
Chapter 3: Hardware Details .....	11
Option Selections .....	11
USB Connector .....	11
Embedded USB Connector .....	11
LED .....	12
DC Power Jack (Optional) .....	12
-ST Screw Terminals for High Retention Ext. Power .....	12
DIO Pull up / Pull down Jumper Configuration .....	12
50 Pin Box Header .....	12
5V Resettable Fused Output .....	12
Chapter 4: USB Address Information .....	13
Chapter 5: Programming .....	14
Chapter 6: Connector Pin Assignments .....	15
Table 6-1: 50-Pin Connector Pin Assignments .....	15
Chapter 7: Specifications .....	16
Customer Comments .....	17

# Chapter 1: Introduction

## Features

- 32 lines of digital I/O buffered with 32 mA source, 64mA sink current capabilities
- High-speed USB 2.0 device, USB 3.0 compatible
- All lines independently selectable for inputs or outputs
- Terminal block adapter card for easy wiring
- I/O Buffers can be enabled or tri-stated under program control
- I/O's pulled up to 5V (via 10K $\Omega$ ) for dry-contact monitoring or pulled down to ground via configuration jumpers (per 8 channel group)
- Jumper selectable power provided via USB cable or external power supply for higher source current capabilities
- Resettable fused +5VDC output
- Standard 50pin IDC type connector with key
- PC/104 size (3.550 by 3.775 in.)
- Rugged industrial enclosure
- Compatible with Industry-Standard I/O Racks such as Gordos, OPTO22, Potter & Brumfield, etc. with optional cable

## Applications

- Automatic Test Systems
- Laboratory Automation
- Robotics
- Machine Control
- Security Systems, Energy Management
- Relay Monitoring and Control
- Parallel Data Transfer to PC
- Sensing Switch Closures or TTL, DTL, CMOS Logic
- Driving Indicator Lights or Recorders

## Functional Description

This USB board is an ideal solution for adding portable, easy-to-install digital I/O to any computer with a USB port. The USB-DIO-32I is a USB 2.0 high-speed device, offering the highest speed available on the USB 2.0 bus. It is fully compatible with both USB 1.1 and USB 3.0 ports. The card is plug-and-play allowing quick connect/disconnect whenever you need additional I/O on your USB port.

The board features 32 bits of TTL-compatible digital I/O with high-current capabilities. Each digital line can be programmed to accept an input or to drive an output. Power is supplied to the card via the USB cable or for higher source current capabilities, external power may be used. The I/O wiring connections are via an industry standard 50-pin connector or via an included removable screw terminal adapter. For external circuits, fused +5VDC power is available at the connector. The resettable fuse is rated at 0.5A.

All I/O lines are buffered by a type ABT tri-stateable buffer transceiver capable of sourcing 32 mA or sinking 64 mA. The buffers are configured under program control for input or output. I/O lines are pulled-up or down via configuration jumpers through 10K $\Omega$  to +5 VDC or ground for confidence of the I/O line states at known levels when the device is powered up and initializing.

For compatibility with industry standard solid state module mounting racks, external power is required for the logic side of the module mounting rack as the load is typically greater than what can be provided over a USB port.

Unlike most USB digital I/O products which primarily use a human interface device (HID) driver, we provide an easy to use, Windows-based, custom function driver optimized for maximum data throughput. This approach exposes the full functionality of the hardware along with maximizing the advantage of using the high-speed USB 2.0 bus.

The board is designed to be used in rugged industrial environments but is small enough to fit nicely onto any desk or testing station. The board is PC/104 size (3.550 by 3.775 inches) and ships inside a steel powder-coated enclosure with an anti-skid bottom.

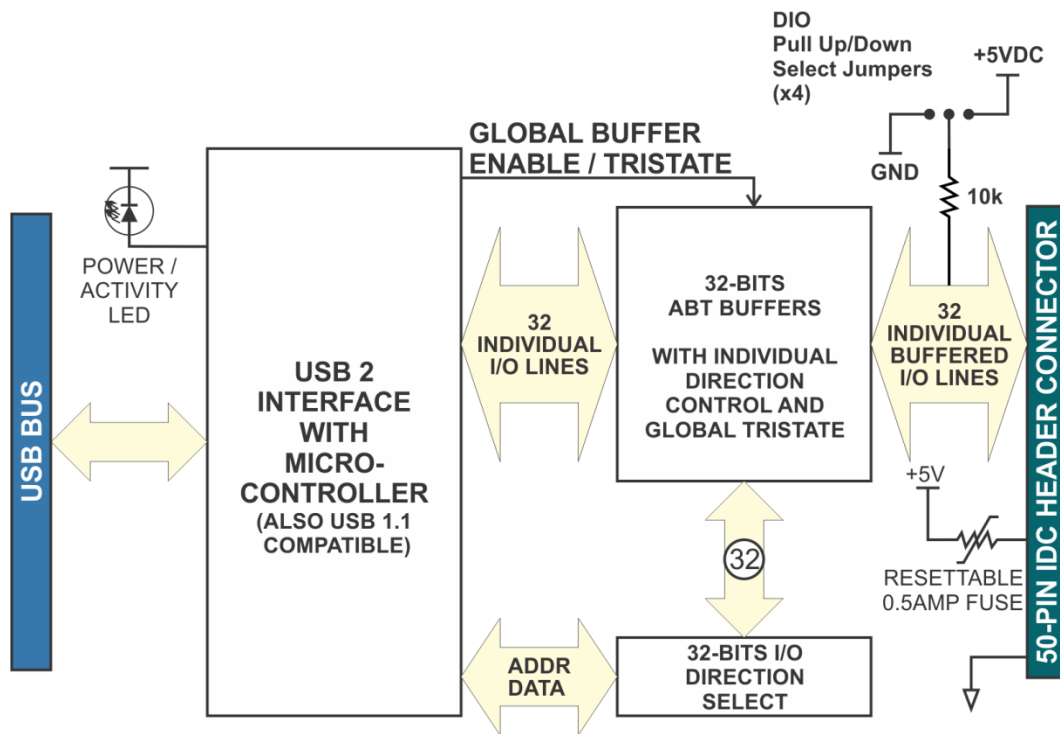

**Figure 1-1: Block Diagram**

## Ordering Guide

- USB-DIO-32I USB 32-individually selectable I/O digital module

## Model Options

- -T Extended operating temperature of -40 to +85°C
- -OEM Board only version with no enclosure
- -E Economy version includes no screw terminal
- -PR On-board DC power circuitry and ext. power AC to regulated 5VDC adapter
- -ST High-retention screw terminals for ext. power connection instead of DC jack
- -RoHS This product is available in a RoHS compliant version
- -U Replace right angle I/O connector with 50-pin straight up

## Special Order

- -S0x Contact factory with your special requirement. Examples of special orders would be conformal coating, latching I/O headers, higher sink / source current, compatibility with industry standard 24 line solid state module racks etc..

## Customization and Special Functions







Due to the nature of our USB modules, many special functions can be implemented with a combination of custom firmware and an associated DLL entry point, for little to no NRE. Functions such as quadrature input, pulse-width modulated outputs, even input de-bouncing. Call us to discuss your requirement!

## Included with your board

The following components are included with your shipment, depending on options ordered. Please take the time now to ensure that no items are damaged or missing.

- USB Module in labeled enclosure with an anti-skid bottom
- Universal screw terminal block
- 6' USB 2.0 cable

## Optional Accessories

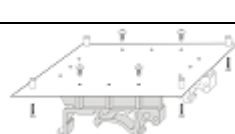
<ul style="list-style-type: none"> <li>• CUSB-EMB-X</li> </ul>	USB Type A to micro-fit OEM header, X=1 for 1' cable, 6 for 6' cable	
<ul style="list-style-type: none"> <li>• CAB50F-6</li> </ul>	Six-foot ribbon cable assembly with 50-pin female connectors	
<ul style="list-style-type: none"> <li>• CAB50-6</li> </ul>	Six-foot ribbon cable assembly with a 50-pin female header connector and a 50-pin female edge connector	
<ul style="list-style-type: none"> <li>• STB-50</li> </ul>	Screw terminal board, typically ships with standoffs but can also mount on SNAP-TRACK or DIN-SNAP	
<ul style="list-style-type: none"> <li>• DIN-SNAP-6</li> </ul>	Six inch length of SNAP-TRACK with two clips, for mounting one STB-50 screw terminal board on a DIN rail	
<ul style="list-style-type: none"> <li>• STB-50D</li> </ul>	Direct connect 50-pin removable spring-cage terminal board for -U option	
<ul style="list-style-type: none"> <li>• STB-50U Kit</li> </ul>	Used for mounting the STB-50U to the enclosure of the USB-DIO-32I. Includes STB-50U, cable and specialized mounting hardware.	
<ul style="list-style-type: none"> <li>• MP104-DIN</li> </ul>	DIN-rail mounting adapter plate for affixing any USB/104 module to a DIN-rail	





# USB-DIO-32I

32 Bits of Individually Direction Selectable Digital I/O

PIN FUNCTION	PIN FUNCTION
1 DIO C7	2 GND
3 DIO C6	4 GND
5 DIO C5	6 GND
7 DIO C4	8 GND
9 DIO C3	10 GND
11 DIO C2	12 GND
13 DIO C1	14 GND
15 DIO C0	16 GND
17 DIO B7	18 GND
19 DIO B6	20 DIO D7
21 DIO B5	22 DIO D6
23 DIO B4	24 GND
25 DIO B3	26 DIO D5
27 DIO B2	28 GND
29 DIO B1	30 DIO D4
31 DIO B0	32 GND
33 DIO A7	34 DIO D3
35 DIO A6	36 GND
37 DIO A5	38 DIO D2
39 DIO A4	40 GND
41 DIO A3	42 DIO D1
43 DIO A2	44 GND
45 DIO A1	46 DIO D0
47 DIO A0	48 GND
49 +5V	50 GND

Figure 1-2: Enclosure Label

## Chapter 2: Installation

### Software CD Installation

The software provided with this board is available by request on CD (see Optional Accessories in the ordering guide) for a fee, or downloaded via the product page for free and must be installed onto your hard disk prior to use.

### Installing from Downloaded Installer

Download the software package here (<https://accessio.com/files/packages/USB-AIO16-16F Install.exe>) or from the Downloads tab on the product page.

### Installing from CD

Perform the following steps as appropriate for your operating system. Substitute the appropriate drive letter for your drive where you see D: in the examples below.

#### Windows

- a. Place the CD into your CD-ROM drive.
- b. The CD should automatically run the install program. If the install program does not run, click START | RUN and type `D:\INSTALL`, click OK or press `Enter`.
- c. Follow the on-screen prompts to install the software for this board.

#### Linux

Please refer to `linux.htm`, and visit <https://github.com/accessio> for more.

### Hardware Installation

The board can be installed in any USB 2.0 or USB 1.1 port. Please refer to the USB I/O Quick Start Guide which can be found on the CD, for specific, quick steps to complete the hardware and software installation.

# Chapter 3: Hardware Details

## Option Selections

Refer to the settings program installed with the software package. Also, refer to the Block Diagram when reading this section of the manual.

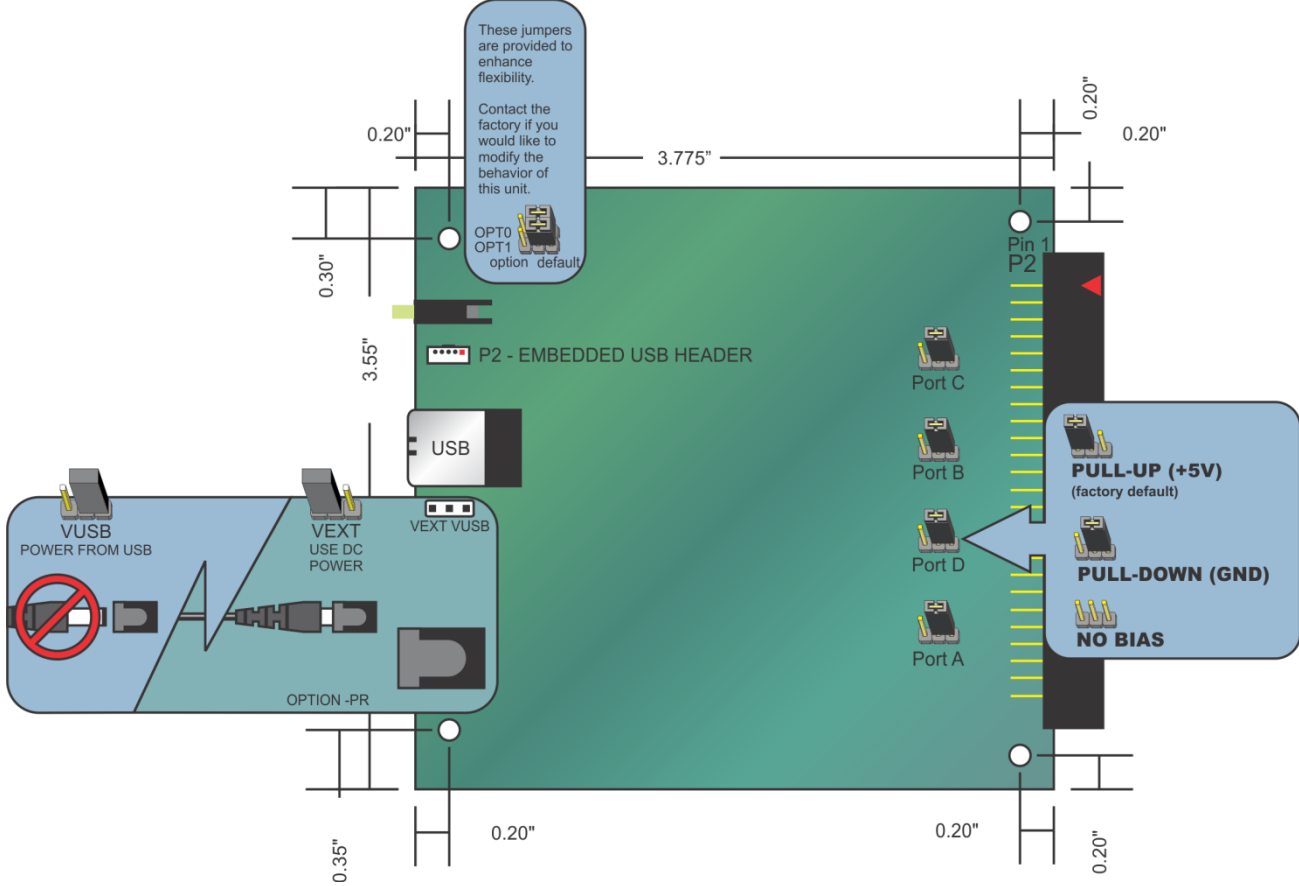

## USB Connector

The primary USB connector is a Type B high-retention connector and mates with the cable provided. The USB port provides communication signals along with +5 VDC power. The board can be powered from the USB port or, if needed for higher source current applications, an external power supply can be used.

## Embedded USB Connector

Micro 5-pin header provides embedded devices with a compact USB interface. Use this with one of our OEM USB cables.

## **LED**

The LED on the front of the enclosure is used to indicate power and data transmissions. When the LED is in an illuminated steady green state, this signifies that the board is successfully connected to the computer and has been detected and configured by the operating system. When the LED flashes continuously, this signifies that there is data being transmitted over the USB bus.

## **DC Power Jack (Optional)**

This is an option for high source current applications when more current is needed than what your computer can provide on the USB port (typically 500 mA). The DC jack has a 2.00mm post on board and is designed to be used with the 5 VDC AC/DC external power supply that ships with this option (-PR). When using external power, switch the jumper located near the USB connector to VEXT, otherwise when the jumper is in the VUSB position current is drawn from the USB port (please consult the option selection map for a visual reference).

## **-ST Screw Terminals for High Retention Ext. Power**

Specify “-ST” when ordering the OEM version of this board to connect external power via secure screw terminals instead of a non-retained DC jack. Strip your wires approximately 4mm and tin, then tighten the regulated +5 VDC source leads into the labeled terminals.

## **DIO Pull up / Pull down Jumper Configuration**

4 sets of jumpers are used to field select 10k ohm pull-up or pull down resistors for four groups of 8 DIO lines.

## **50 Pin Box Header**

The 50 pin box header has standard .100" spacing between pins and is keyed to prevent improper connections. It can be used with standard IDC type ribbon cables or the included screw terminal board that plugs directly into the box header.

## **5V Resettable Fused Output**

A 0.5A resettable fuse at pin 49 may be used to power external module racks or relay boards and such. If an over-current persists on a circuit protected by a resettable fuse, it will open interrupting power to the circuit. Response time depends on over-current level and ambient temperature, humidity, etc. The fuse will remain open until the bi-metal elements cool sufficiently, at which time the circuit will be restored.

## Chapter 4: USB Address Information

Use the provided driver to access the USB board. This driver will allow you to determine how many supported USB devices are currently installed, and each device's type. This information is returned as a Vendor ID (VID), Product ID (PID) and Device Index.

The board's VID is "0x1605", and its PID is "0x8004".

The Device Index is determined by how many of the device you have in your system, and provides a unique identifier allowing you to access a specific board at will.

## Chapter 5: Programming

The driver software provided with the board uses a 32-bit .dll front end compatible with any Windows programming language. Samples provided in Borland Delphi, Microsoft Visual Basic, Microsoft Visual C++ and C# demonstrate the use of the driver.

The following functions are provided by the driver in Windows.

These functions will allow you to read or write individual bits, bytes, or the entire board worth of data. In addition, board-level functions complete the driver package.

For detailed information on each function refer to the USB Software Reference Manual.PDF located in the <cardname> directory for this board. A C# Development Guide.PDF is located in C:\Program Files\ACCES\USB-DIO-32I\Win32\Driver.SRC\AIIOUSBNetSLN (assuming defaults are accepted when installing from the CD).

```
unsigned long GetDevices(void )
unsigned long QueryDeviceInfo(DeviceIndex, pPID, pName, pDIOBytes, pCounters)
unsigned long DIO_Configure(DeviceIndex, bTristate, pOutMask, pData)
unsigned long DIO_Write1(DeviceIndex, BitIndex, bData)
unsigned long DIO_Write8(DeviceIndex, ByteIndex, Data)
unsigned long DIO_WriteAll(DeviceIndex,pData)
unsigned long DIO_Read8(DeviceIndex, ByteIndex,pBuffer)
unsigned long DIO_ReadAll(DeviceIndex,Buffer)
```

## Chapter 6: Connector Pin Assignments

A 50-pin male header connector protrudes through a cutout in the enclosure for I/O connections. Connector pin assignments are listed below.

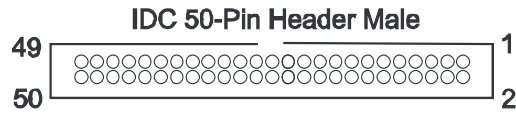

**Table 6-1: 50-Pin Connector Pin Assignments**

PIN	FUNCTION	PIN	FUNCTION
1	DIO C7	2	GND
3	DIO C6	4	GND
5	DIO C5	6	GND
7	DIO C4	8	GND
9	DIO C3	10	GND
11	DIO C2	12	GND
13	DIO C1	14	GND
15	DIO C0	16	GND
17	DIO B7	18	GND
19	DIO B6	20	DIO D7
21	DIO B5	22	DIO D6
23	DIO B4	24	GND
25	DIO B3	26	DIO D5
27	DIO B2	28	GND
29	DIO B1	30	DIO D4
31	DIO B0	32	GND
33	DIO A7	34	DIO D3
35	DIO A6	36	GND
37	DIO A5	38	DIO D2
39	DIO A4	40	GND
41	DIO A3	42	DIO D1
43	DIO A2	44	GND
45	DIO A1	46	DIO D0
47	DIO A0	48	GND
49	Fused +5VDC	50	GND

## Chapter 7: Specifications

### Digital Inputs (TTL Compatible, @ 4kHz)

Logic High: 2.0 to 5.0 VDC  
Logic Low: -0.5 to +0.8 VDC

### Digital Outputs

Logic High: 2.0 VDC minimum, source 32 mA  
Logic Low: 0.55 VDC maximum, sink 64 mA

Pull-Up / -Down Resistor: 10k ohms (to +5V or GND)

**Bus Type:** USB 2.0 High-speed,  
USB 3.0 Compatible  
USB 1.1 Full-speed compatible

### Environmental

Operating Temp: 0° to 70°C  
Storage Temp: -40° to +85°C  
Humidity: 5%-95%, non-condensing  
Board Dim.: 3.550 x 3.775 inches  
Box Dim.: 4.0 x 4.0 x 1.25 inches

### Power

+5VDC: 60mA (All inputs, no load)  
150mA (All outputs low, no load) provided via USB at up to 500mA\*\*

\*\*+5 VDC from the USB bus or external power supply depending on user configuration. The USB bus is specified to provide 500 mA to most desktop environments. This gives you 350mA available (500 mA - 150mA = 350 mA). If using more than a total of 500mA, use optional Regulated 5 VDC external power supply and remove VUSB jumper and place jumper on VEXT. Then plug in external power before plugging into USB port.



## Customer Comments

If you experience any problems with this manual or just want to give us some feedback, please email us at: ***manuals@acesio.com***. Please detail any errors you find and include your mailing address so that we can send you any manual updates.

